

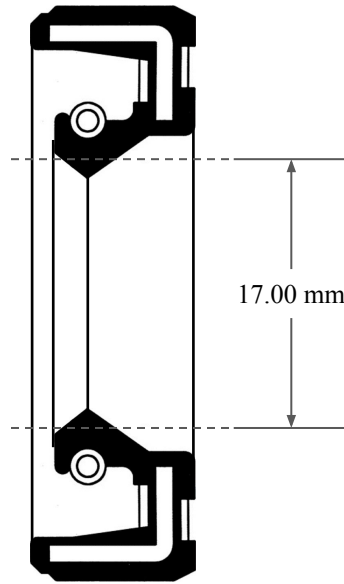

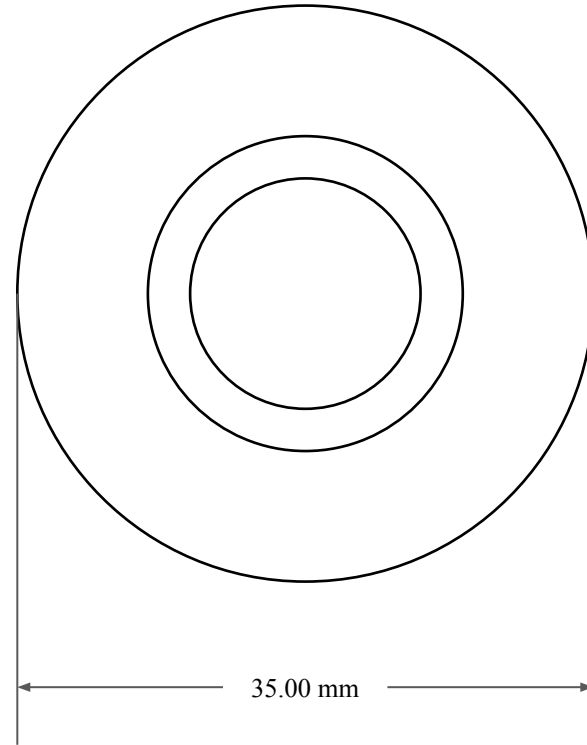

6.00 mm



17.00 mm



35.00 mm

 ALL-AROUND BETTER	PART NUMBER <b>MOS1462SC</b>
14450 John F. Kennedy Blvd. Houston, TX 77032	www.globaloring.com
Information in this drawing is provided for reference only	
Metric Oil Seal - Nitrile Style SC SGL LIP W/ SPR, RBR OD	