

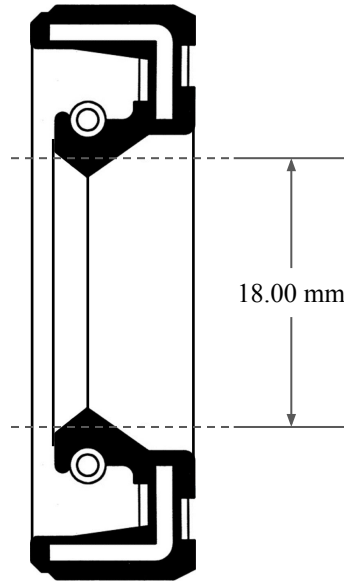

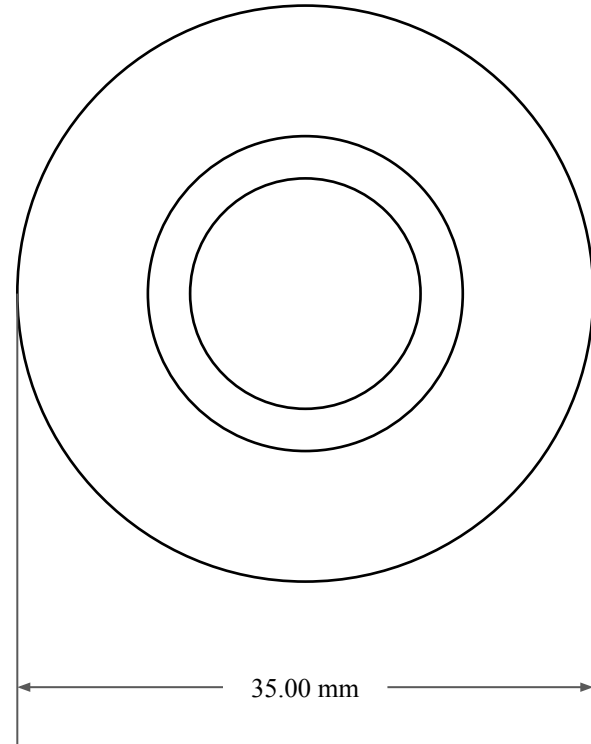

8.00 mm



18.00 mm



35.00 mm

 GLOBAL O-RING and SEAL ALL-AROUND BETTER	PART NUMBER MOS1606SC
14450 John F. Kennedy Blvd. Houston, TX 77032	www.globaloring.com
Information in this drawing is provided for reference only	

Metric Oil Seal - Nitrile Style SC
SGL LIP W/ SPR, RBR OD