

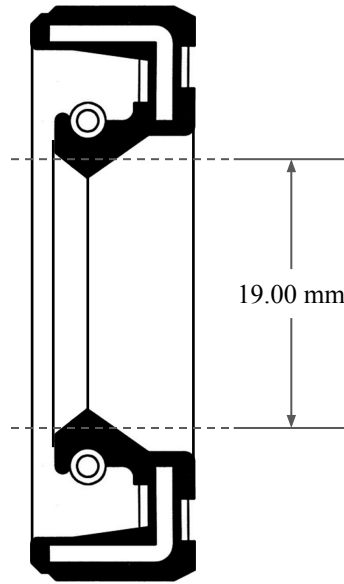

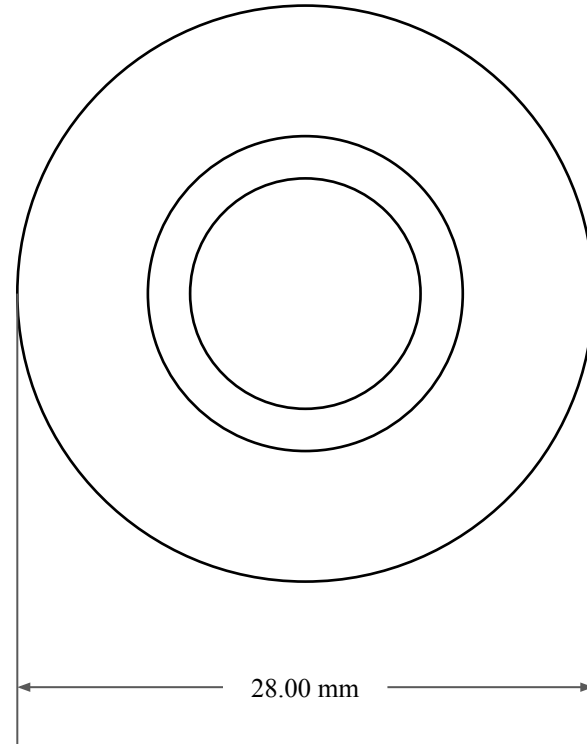

6.00 mm



19.00 mm



28.00 mm

 ALL-AROUND BETTER	PART NUMBER MOS1667SC
14450 John F. Kennedy Blvd. Houston, TX 77032	www.globaloring.com
Information in this drawing is provided for reference only	

Metric Oil Seal - Nitrile Style SC
SGL LIP W/ SPR, RBR OD