

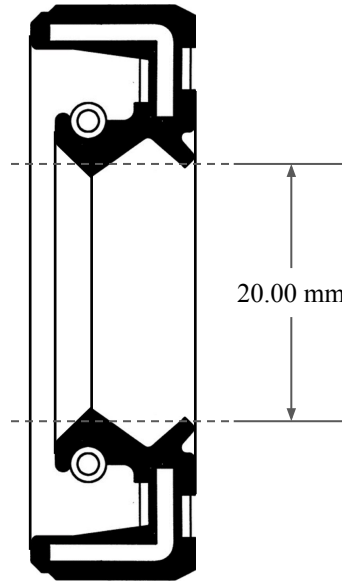

6.00 mm

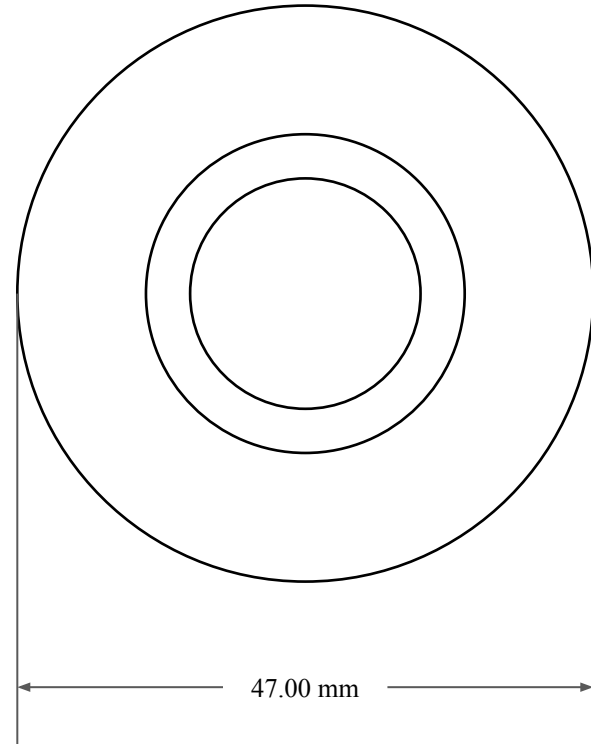

20.00 mm



47.00 mm



GLOBAL O-RING
and SEAL
ALL-AROUND BETTER

14450 John F. Kennedy Blvd.
Houston, TX 77032

www.globaloring.com

PART
NUMBER

MOS2009TC

Metric Oil Seal - Nitrile Style TC
DUAL LIP W/ SPR, RBR OD

Information in this drawing is provided for reference only