

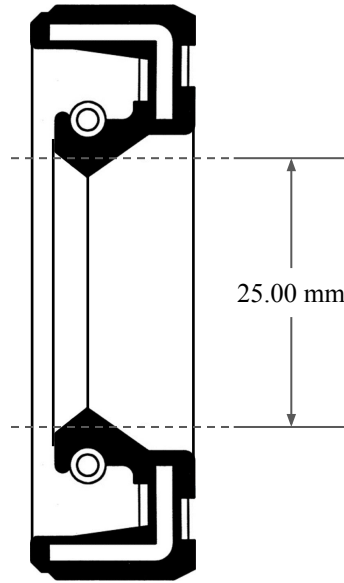

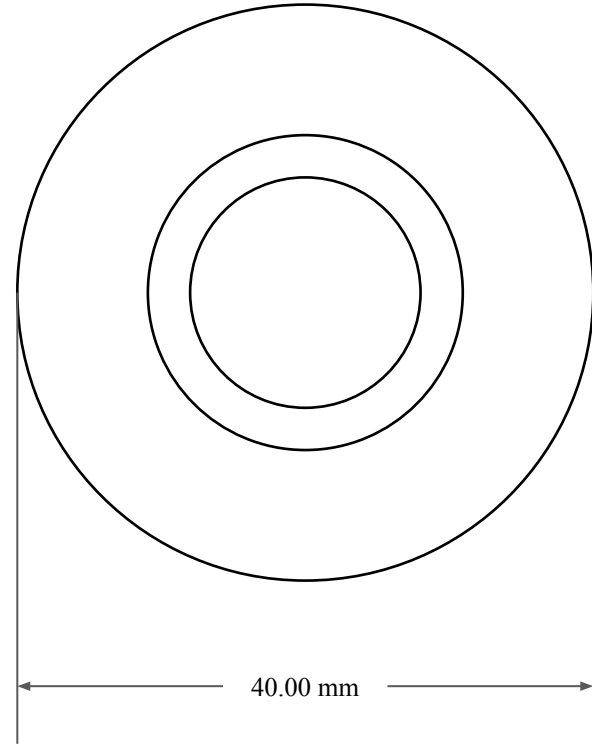

10.00
mm



25.00 mm



40.00 mm

 GLOBAL O-RING and SEAL ALL-AROUND BETTER	PART NUMBER MOS2700SC
14450 John F. Kennedy Blvd. Houston, TX 77032 www.globaloring.com	Metric Oil Seal - Nitrile Style SC SGL LIP W/ SPR, RBR OD
Information in this drawing is provided for reference only	