

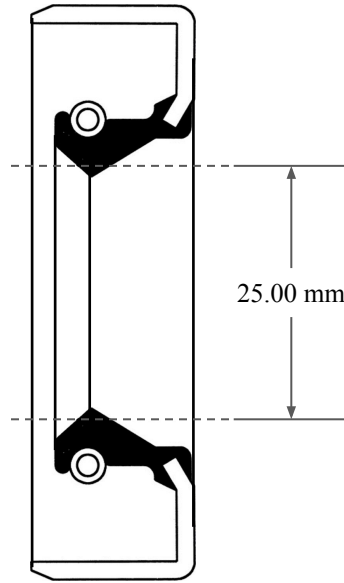

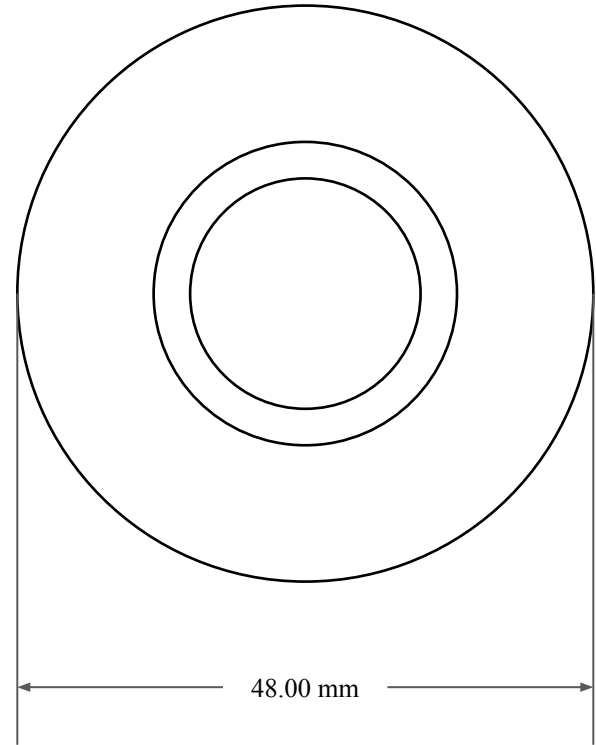

8.00 mm



25.00 mm



48.00 mm

|   |   |
|---|---|
|  <b>GLOBAL O-RING</b><br>and SEAL<br>ALL-AROUND BETTER | PART NUMBER<br><b>MOS2767SB2</b>                              |
| 14450 John F. Kennedy Blvd.<br>Houston, TX 77032  | Metric Oil Seal - Nitrile Style SB2<br>SGL LIP W/ SPR, MTL OD |
| Information in this drawing is provided for reference only  |   |