

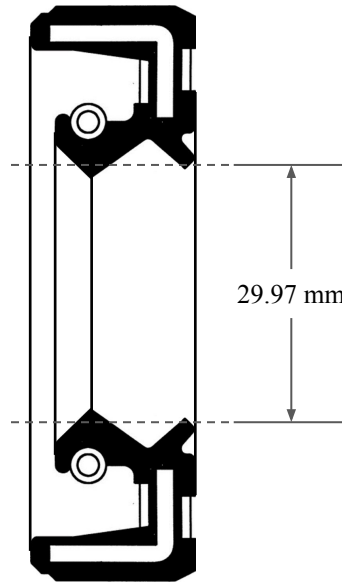

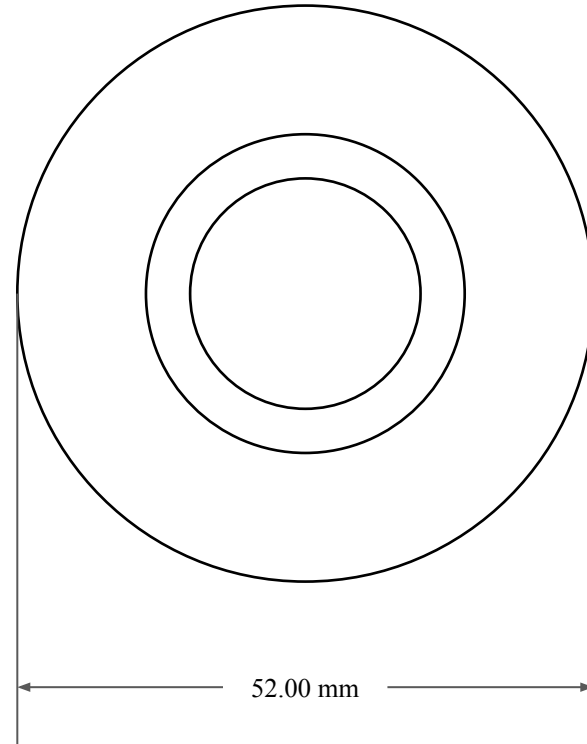

10.00  
mm



29.97 mm



52.00 mm

 <b>GLOBAL O-RING and SEAL</b> ALL-AROUND BETTER	PART NUMBER <b>MOS3631TC</b>
14450 John F. Kennedy Blvd. Houston, TX 77032	www.globaloring.com
Information in this drawing is provided for reference only	

Metric Oil Seal - Nitrile Style TC  
DUAL LIP W/ SPR, RBR OD