

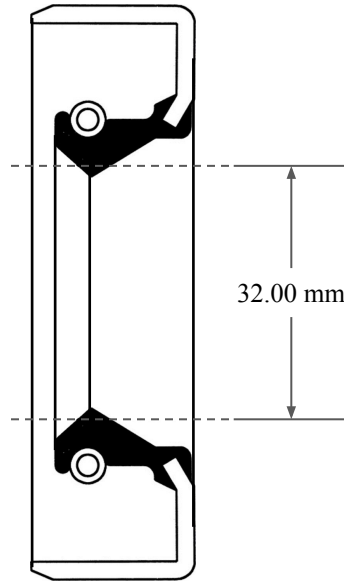

12.00
mm

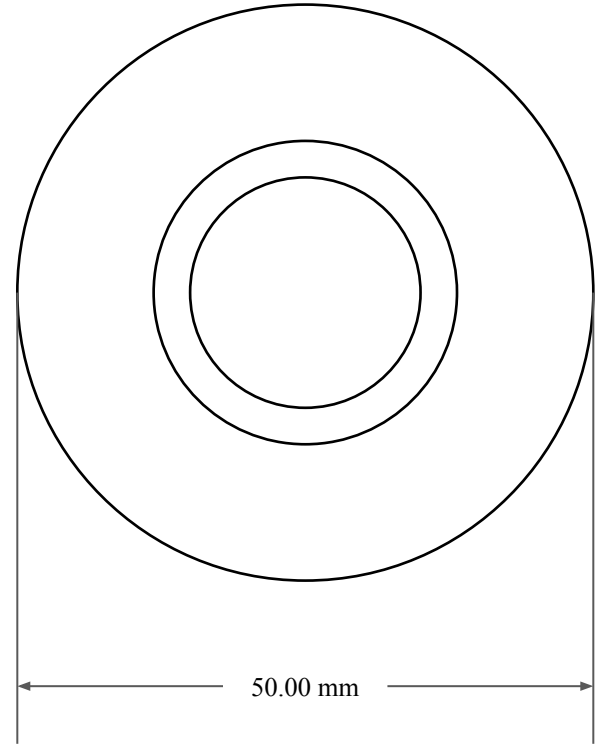

32.00 mm



50.00 mm



14450 John F. Kennedy Blvd. www.globaloring.com
Houston, TX 77032

Information in this drawing is provided for reference only

PART
NUMBER

MOS4218SB2

Metric Oil Seal - Nitrile Style SB2
SGL LIP W/ SPR, MTL OD