

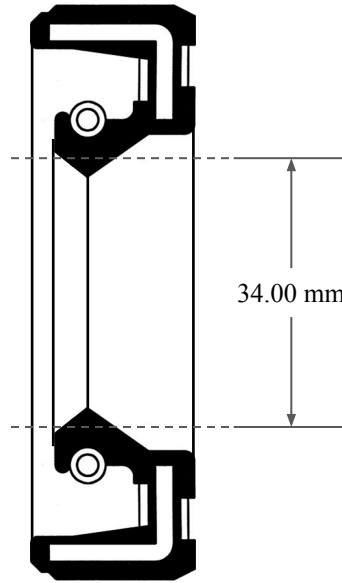

10.00  
mm

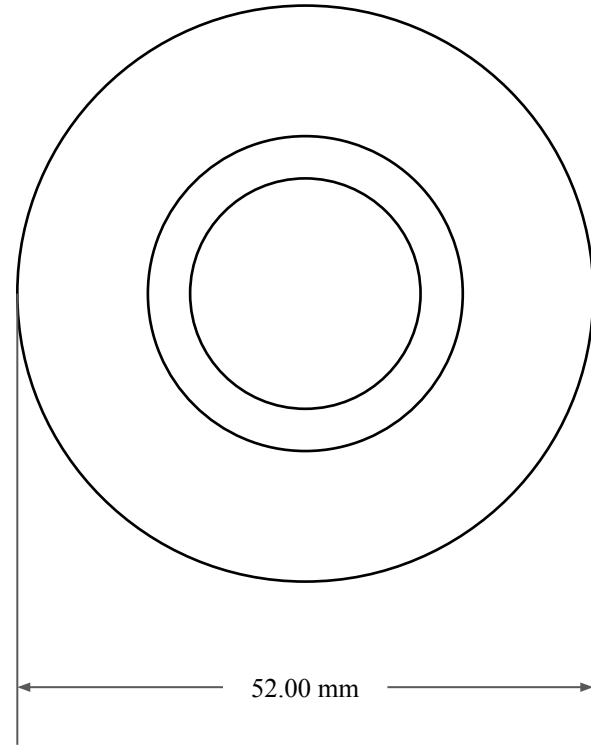

34.00 mm



52.00 mm



**GLOBAL O-RING**  
and SEAL  
ALL-AROUND BETTER

14450 John F. Kennedy Blvd.  
Houston, TX 77032

[www.globaloring.com](http://www.globaloring.com)

PART  
NUMBER

**MOS4502SC**

Metric Oil Seal - Nitrile Style SC  
SGL LIP W/ SPR, RBR OD

Information in this drawing is provided for reference only