

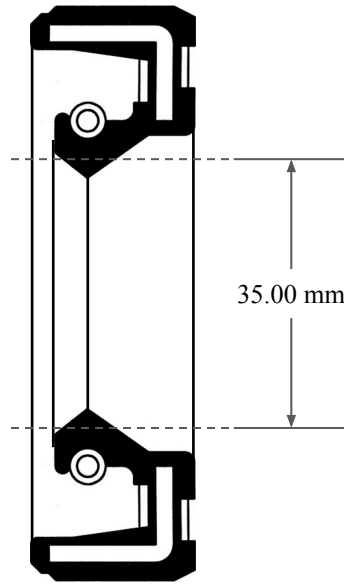

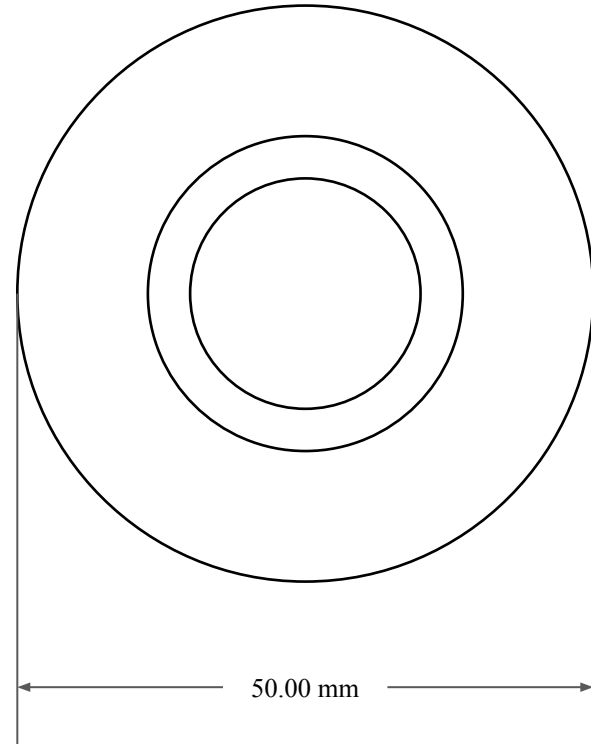

12.00  
mm



35.00 mm



50.00 mm

 <b>GLOBAL O-RING</b> and SEAL ALL-AROUND BETTER	PART NUMBER <b>MOS4816SC</b>
14450 John F. Kennedy Blvd. Houston, TX 77032	Metric Oil Seal - Nitrile Style SC SGL LIP W/ SPR, RBR OD
Information in this drawing is provided for reference only	