

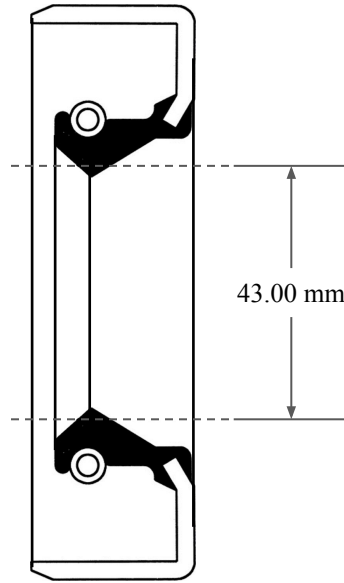

12.00  
mm

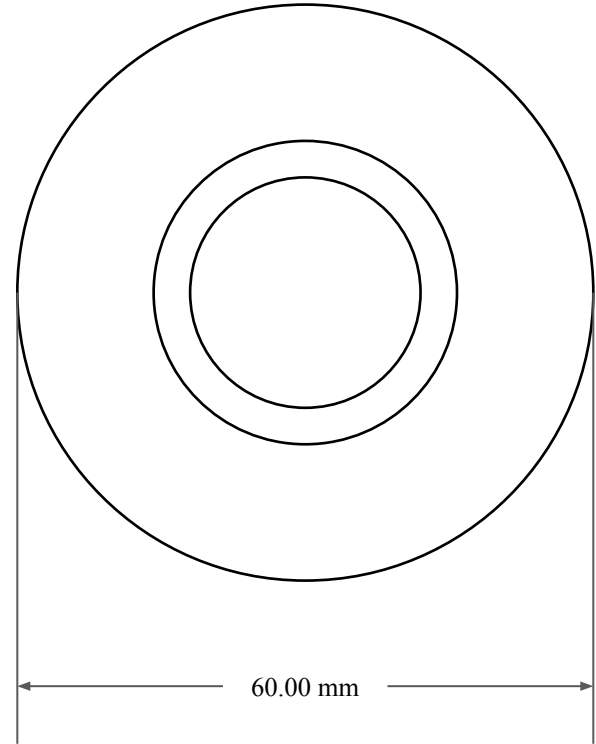

43.00 mm



60.00 mm



14450 John F. Kennedy Blvd.      www.globaloring.com  
Houston, TX 77032

Information in this drawing is provided for reference only

PART NUMBER **MOS6315SB2**

Metric Oil Seal - Nitrile Style SB2  
SGL LIP W/ SPR, MTL OD