

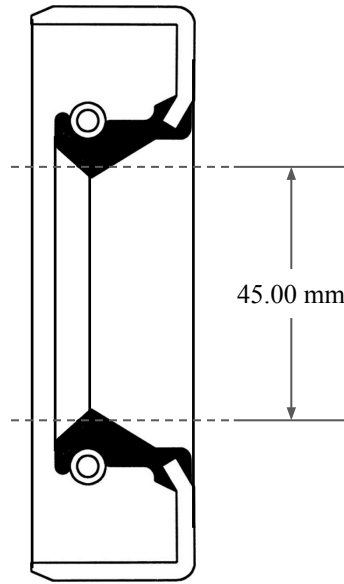

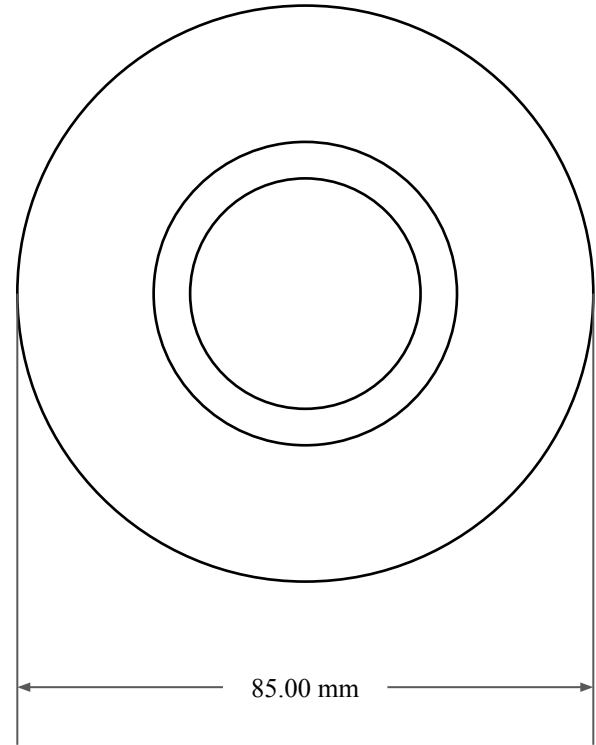

8.00 mm



45.00 mm



85.00 mm

 <b>GLOBAL O-RING</b> and SEAL ALL-AROUND BETTER	PART NUMBER <b>MOS6774SB2</b>
14450 John F. Kennedy Blvd. Houston, TX 77032 <a href="http://www.globaloring.com">www.globaloring.com</a>	<b>Metric Oil Seal - Nitrile Style SB2</b> SGL LIP W/ SPR, MTL OD
Information in this drawing is provided for reference only	