

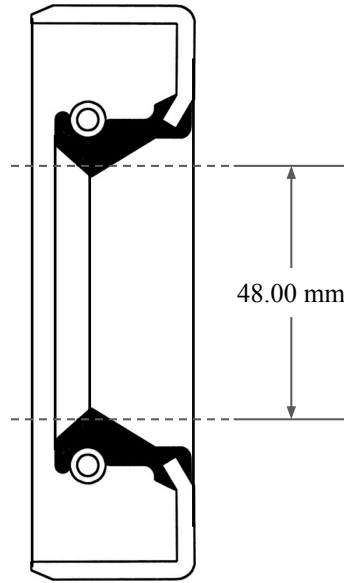

8.00 mm

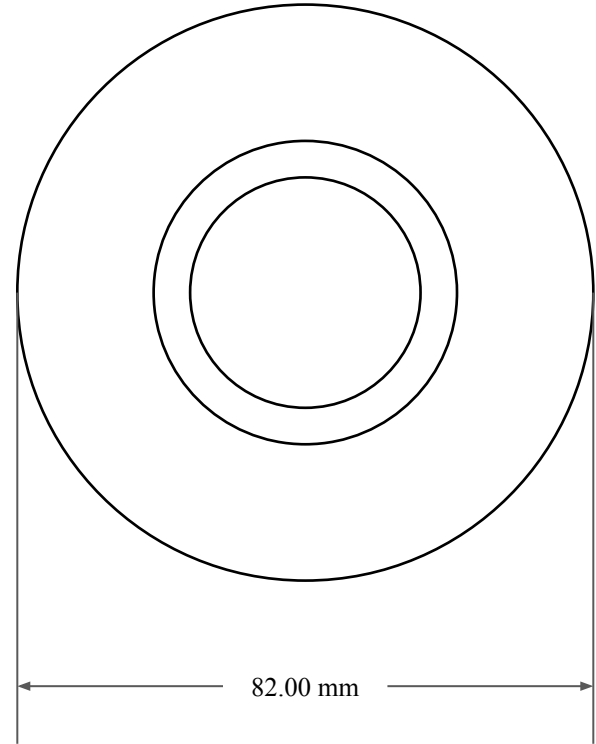

48.00 mm



82.00 mm



14450 John F. Kennedy Blvd. www.globaloring.com
Houston, TX 77032

Information in this drawing is provided for reference only

PART NUMBER **MOS7186SB2**

Metric Oil Seal - Nitrile Style SB2
SGL LIP W/ SPR, MTL OD