

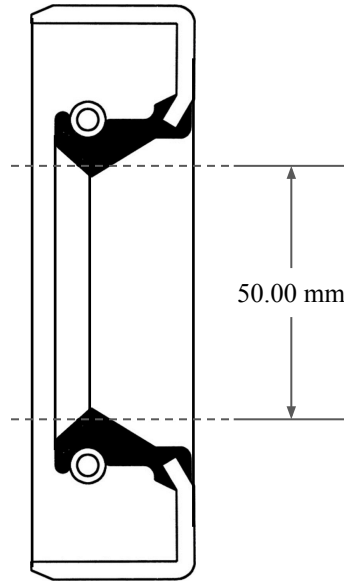

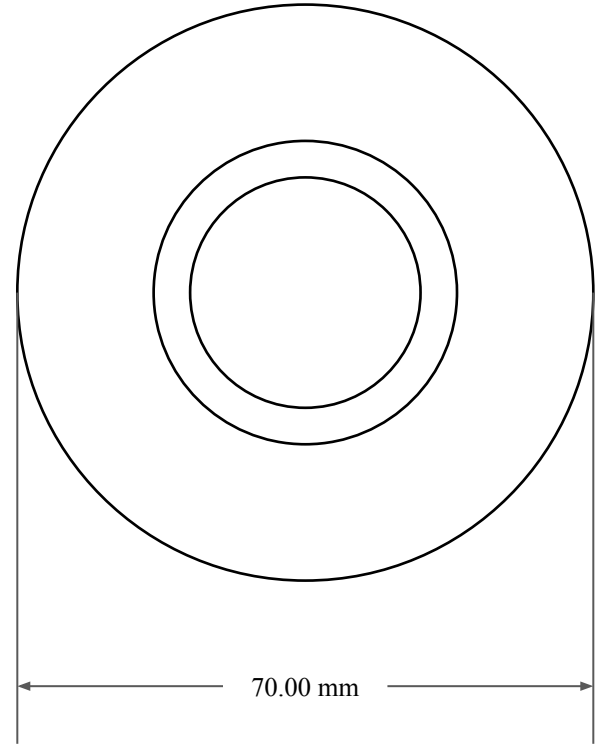

8.00 mm



50.00 mm



70.00 mm

 GLOBAL O-RING and SEAL ALL-AROUND BETTER	PART NUMBER MOS7444SB2
14450 John F. Kennedy Blvd. Houston, TX 77032 www.globaloring.com	Metric Oil Seal - Nitrile Style SB2 SGL LIP W/ SPR, MTL OD
Information in this drawing is provided for reference only	