

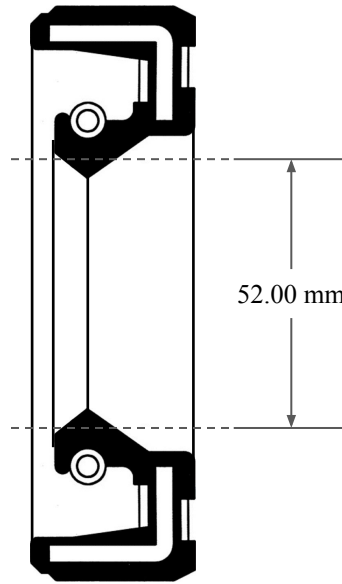

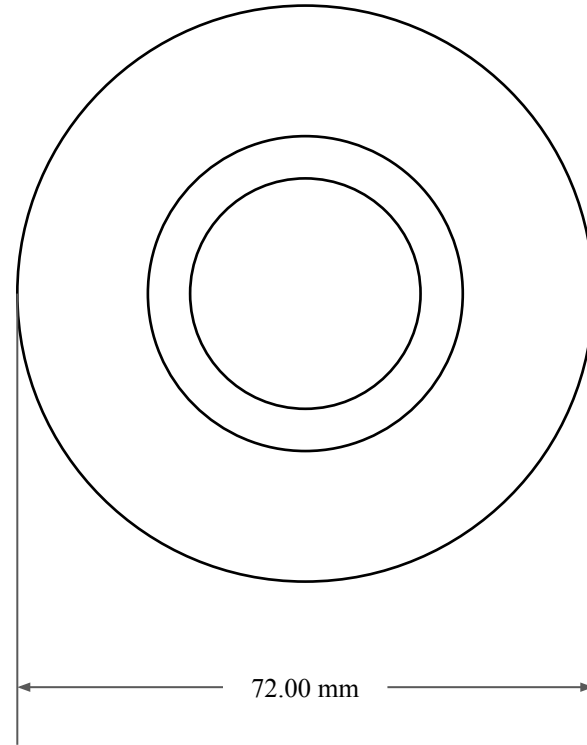

12.00  
mm



52.00 mm



72.00 mm

 <b>GLOBAL O-RING and SEAL</b> ALL-AROUND BETTER	PART NUMBER <b>MOS7771SC</b>
14450 John F. Kennedy Blvd. Houston, TX 77032 <a href="http://www.globaloring.com">www.globaloring.com</a>	<b>Metric Oil Seal - Nitrile Style SC</b>
Information in this drawing is provided for reference only	

**SGL LIP W/ SPR, RBR OD**