

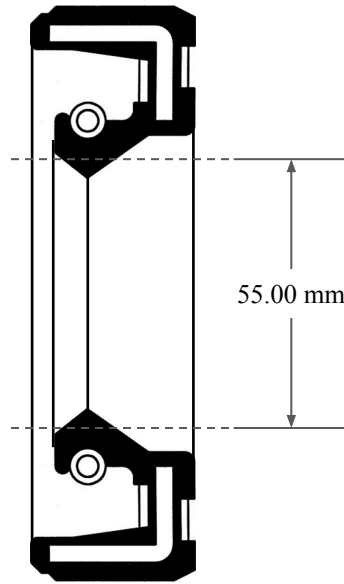

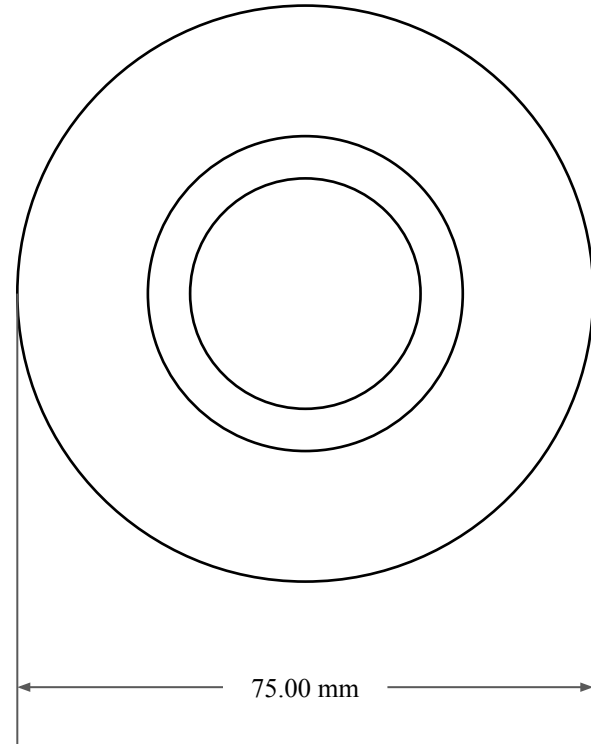

10.00  
mm



55.00 mm



75.00 mm

 ALL-AROUND BETTER	PART NUMBER <b>MOS8123SC</b>
14450 John F. Kennedy Blvd. Houston, TX 77032	www.globaloring.com
Information in this drawing is provided for reference only	

Metric Oil Seal - Nitrile Style SC  
SGL LIP W/ SPR, RBR OD