

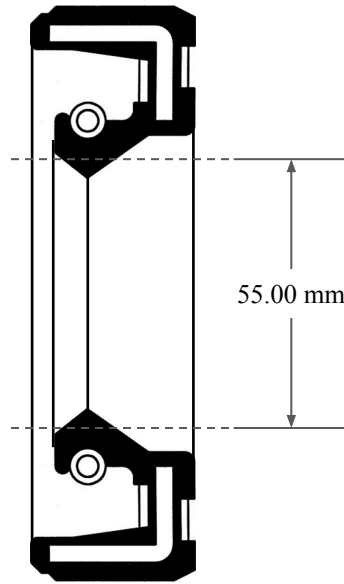

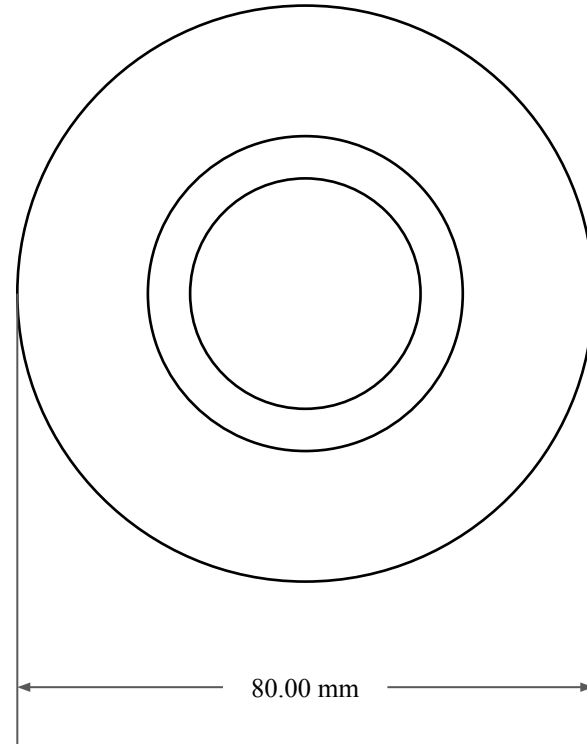

10.00  
mm



55.00 mm



80.00 mm

 <b>GLOBAL O-RING</b> and SEAL ALL-AROUND BETTER	PART NUMBER <b>MOS8147SC</b>
14450 John F. Kennedy Blvd. Houston, TX 77032	www.globaloring.com
Information in this drawing is provided for reference only	
<b>Metric Oil Seal - Nitrile Style SC</b> SGL LIP W/ SPR, RBR OD	