

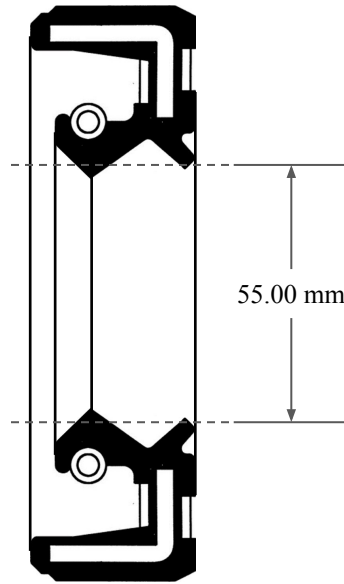

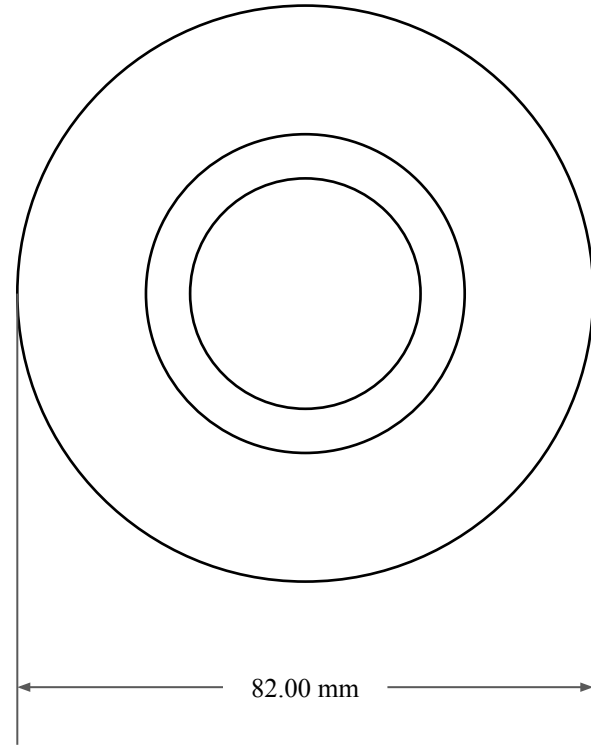

10.00
mm



55.00 mm



82.00 mm

| | |
|---|------------------------------------|
|  GLOBAL O-RING and SEAL ALL-AROUND BETTER | PART NUMBER MOS8152TC |
| 14450 John F. Kennedy Blvd. Houston, TX 77032 | www.globaloring.com |
| Information in this drawing is provided for reference only | |

Metric Oil Seal - Nitrile Style TC
DUAL LIP W/ SPR, RBR OD