

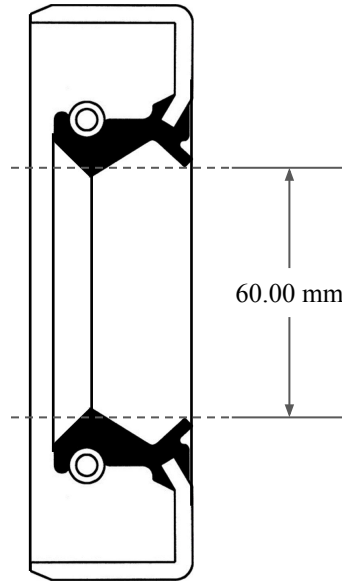

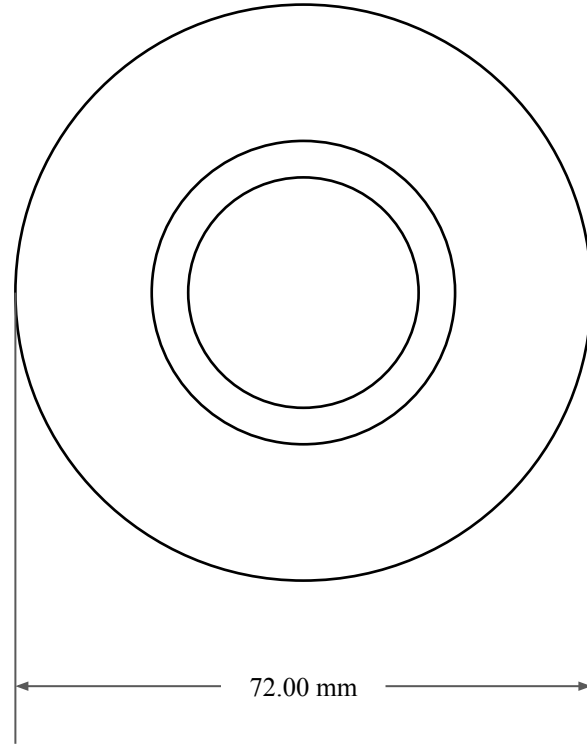

12.00  
mm



60.00 mm



72.00 mm

 <b>GLOBAL O-RING</b> and SEAL ALL-AROUND BETTER	PART NUMBER <b>MOS8629TB2</b>
14450 John F. Kennedy Blvd. Houston, TX 77032	www.globaloring.com
Information in this drawing is provided for reference only	
<b>Metric Oil Seal - Nitrile Style TB2 DUAL LIP W/ SPR, MTL OD</b>	