

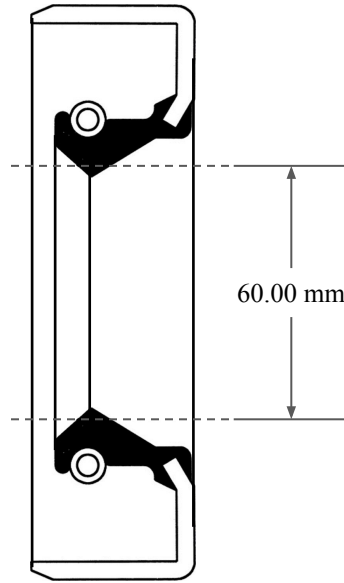

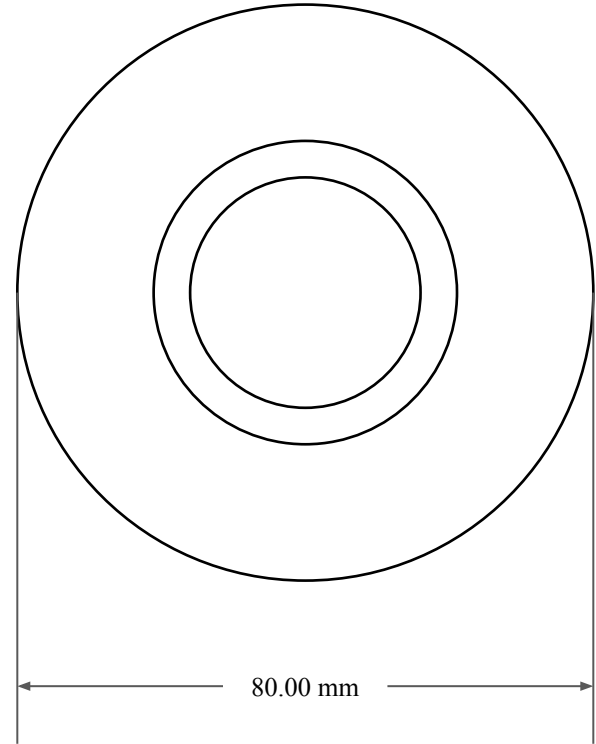

10.00
mm



60.00 mm



80.00 mm

 GLOBAL O-RING and SEAL ALL-AROUND BETTER	PART NUMBER MOS8665SB2
14450 John F. Kennedy Blvd. Houston, TX 77032	www.globaloring.com
Metric Oil Seal - Nitrile Style SB2 SGL LIP W/ SPR, MTL OD	

Information in this drawing is provided for reference only