

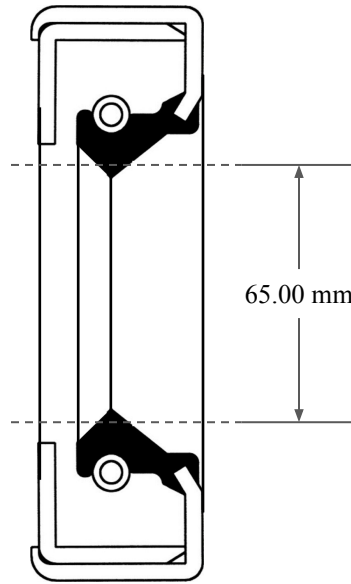

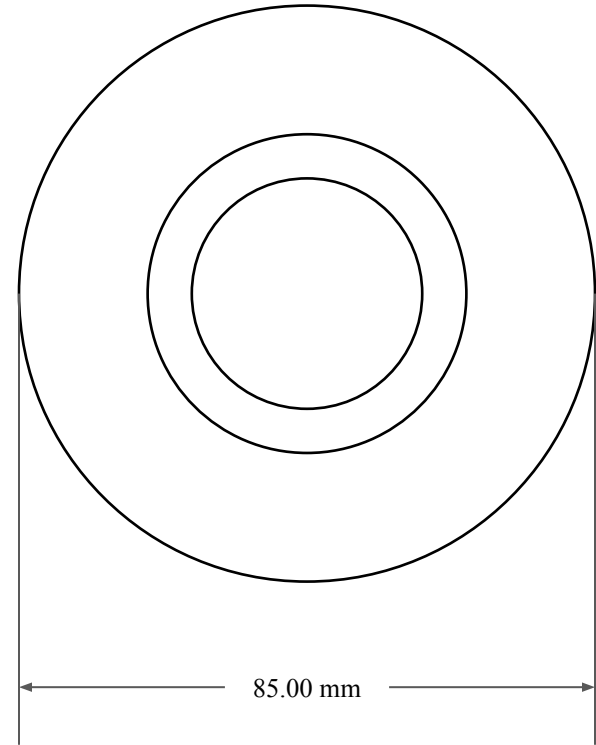

12.00
mm



65.00 mm



85.00 mm

| | |
|---|---|
|  GLOBAL O-RING and SEAL ALL-AROUND BETTER | PART NUMBER MOS9170SA2 |
| 14450 John F. Kennedy Blvd. Houston, TX 77032 www.globaloring.com | Metric Oil Seal - Nitrile Style SA2 SGL LIP W/ SPR, MTL OD W/ RFG PLATE |
| Information in this drawing is provided for reference only | |