

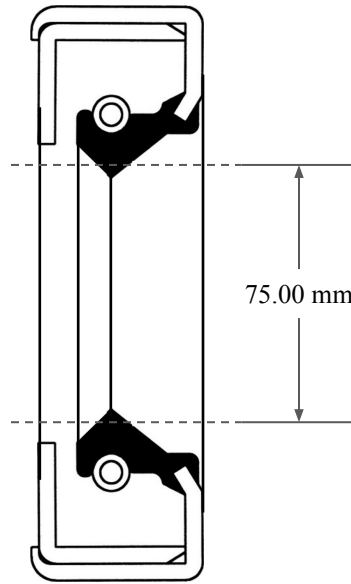

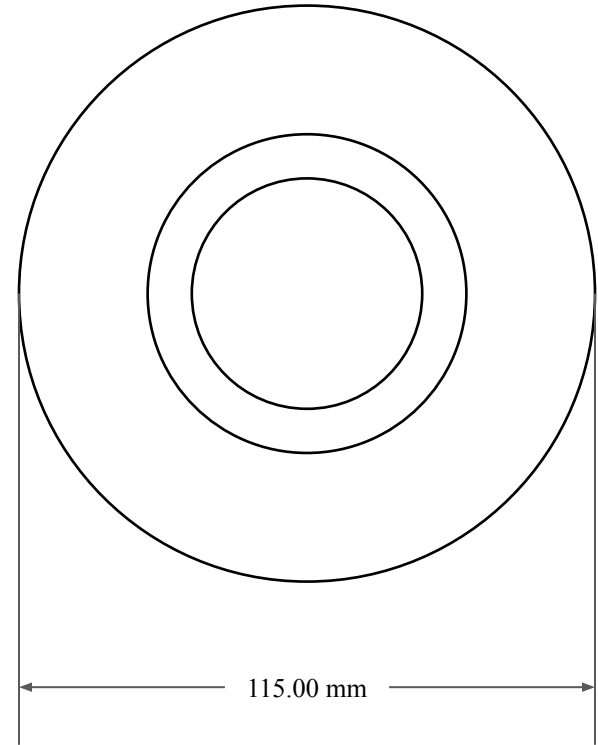

13.00  
mm



75.00 mm



115.00 mm

|   |   |
|---|---|
|  <b>GLOBAL O-RING</b><br>and SEAL<br>ALL-AROUND BETTER | PART<br>NUMBER<br><b>MOS9971SA2</b>   |
| 14450 John F. Kennedy Blvd.<br>Houston, TX 77032<br><a href="http://www.globaloring.com">www.globaloring.com</a>                            | Metric Oil Seal - Nitrile Style SA2<br>SGL LIP W/ SPR, MTL OD W/ RFG<br>PLATE |
| Information in this drawing is provided for reference only  |   |