

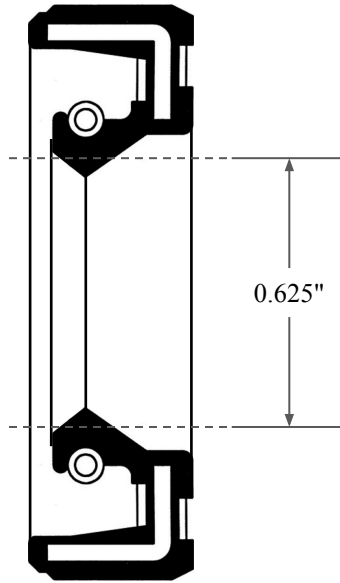

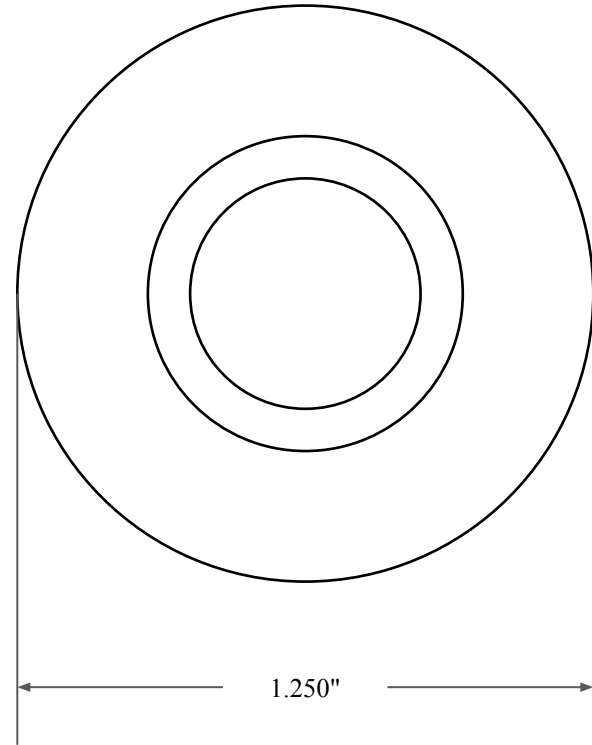

0.310"



0.625"



1.250"

 GLOBAL O-RING and SEAL ALL-AROUND BETTER	PART NUMBER OS1217SC
14450 John F. Kennedy Blvd. Houston, TX 77032	www.globaloring.com
Information in this drawing is provided for reference only	

Inch Oil Seal - Nitrile Style SC
SGL LIP W/ SPR, RBR OD