

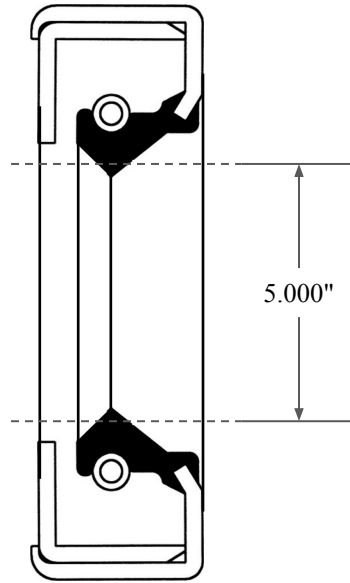

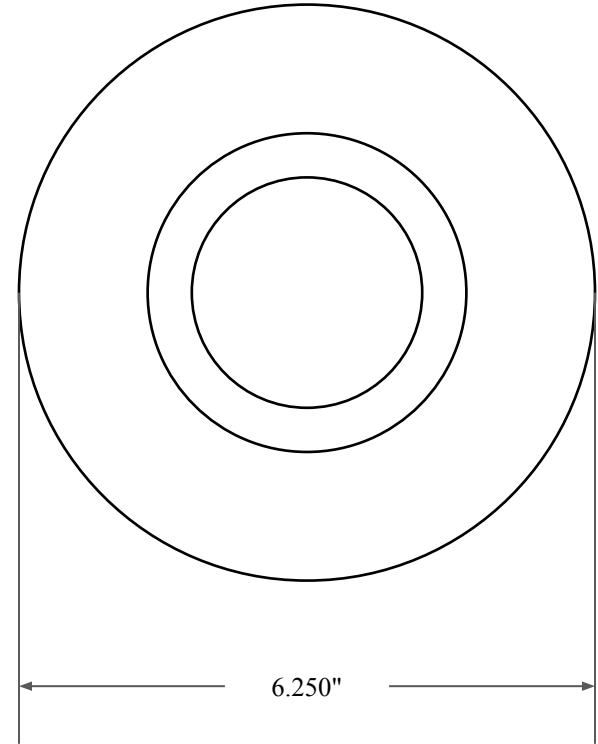

0.563"



5.000"



6.250"

 <b>GLOBAL O-RING</b> and SEAL ALL-AROUND BETTER	PART NUMBER <b>OS12357SA2</b>
14450 John F. Kennedy Blvd. Houston, TX 77032 <a href="http://www.globaloring.com">www.globaloring.com</a>	Inch Oil Seal - Nitrile Style SA2 SGL LIP W/ SPR, MTL OD W/ RFG PLATE
Information in this drawing is provided for reference only	