

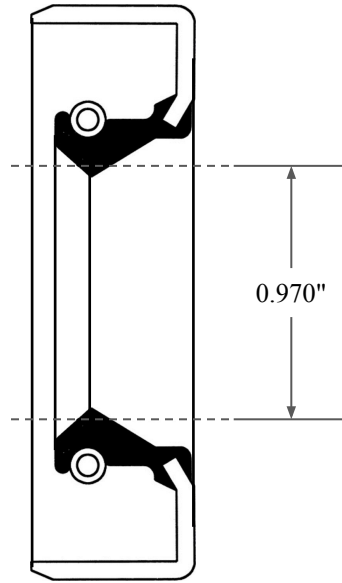

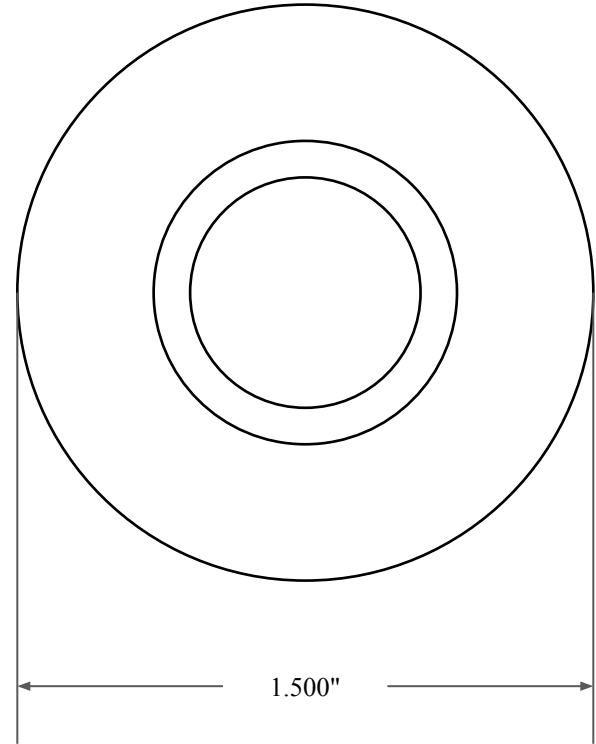

0.250"



0.970"



1.500"

 GLOBAL O-RING and SEAL ALL-AROUND BETTER	PART NUMBER OS20005SB2
14450 John F. Kennedy Blvd. Houston, TX 77032 www.globaloring.com	Inch Oil Seal - Nitrile Style SB2 SGL LIP W/ SPR, MTL OD
Information in this drawing is provided for reference only	