

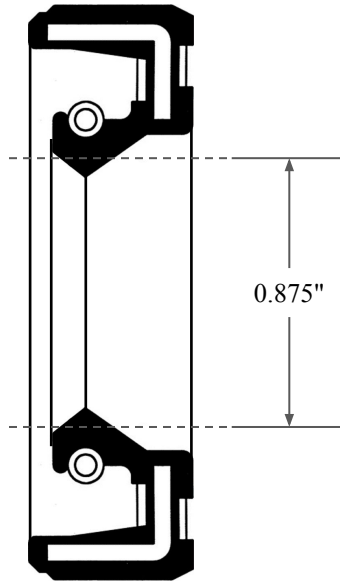

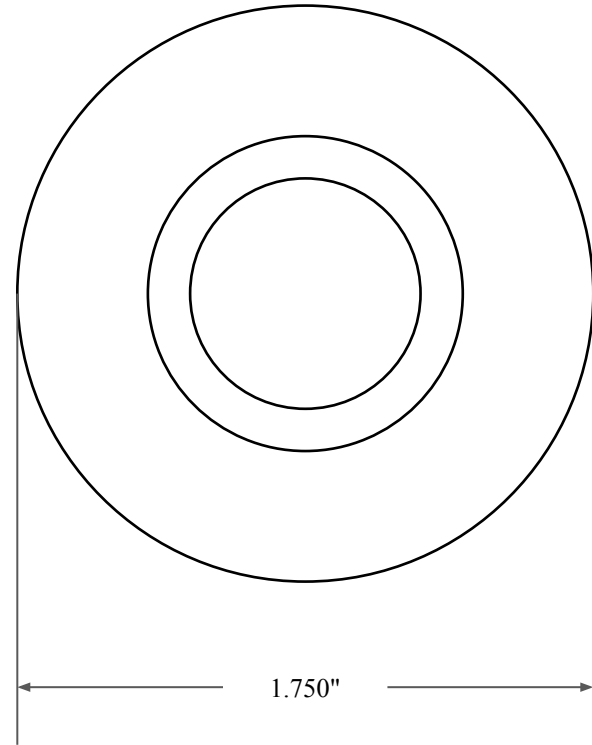

0.375"



0.875"



1.750"

 ALL-AROUND BETTER	PART NUMBER <b>OS2360SC</b>
14450 John F. Kennedy Blvd. Houston, TX 77032	www.globaloring.com
Information in this drawing is provided for reference only	

Inch Oil Seal - Nitrile Style SC  
SGL LIP W/ SPR, RBR OD