

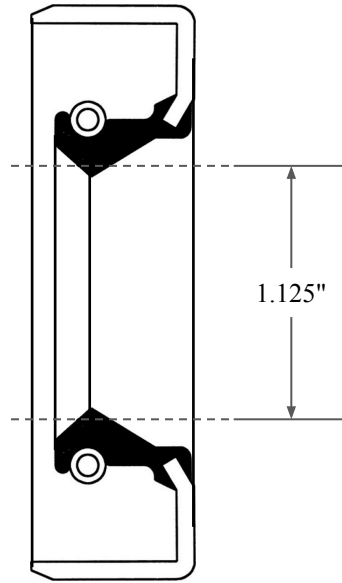

0.250"

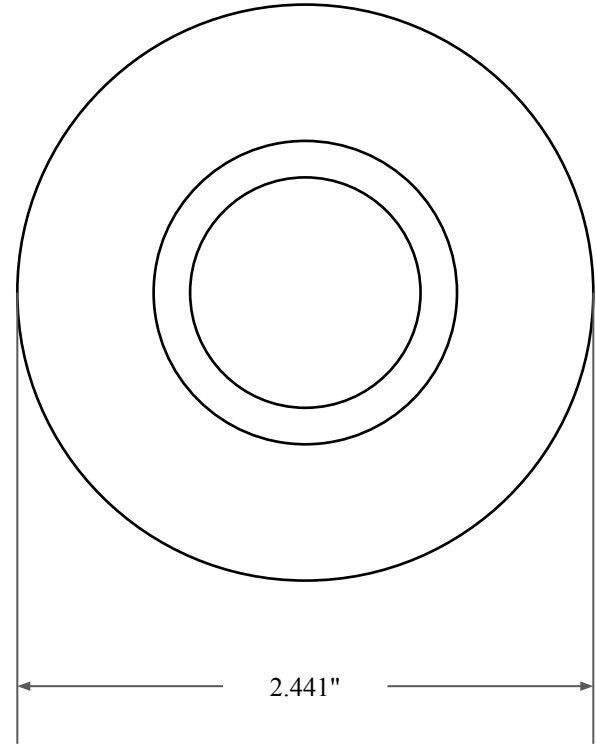

1.125"



2.441"



14450 John F. Kennedy Blvd.
Houston, TX 77032

www.globaloring.com

Information in this drawing is provided for reference only

PART
NUMBER

OS3514SB2

Inch Oil Seal - Nitrile Style SB2
SGL LIP W/ SPR, MTL OD