

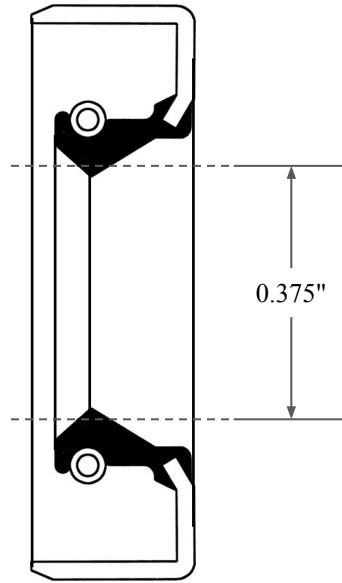

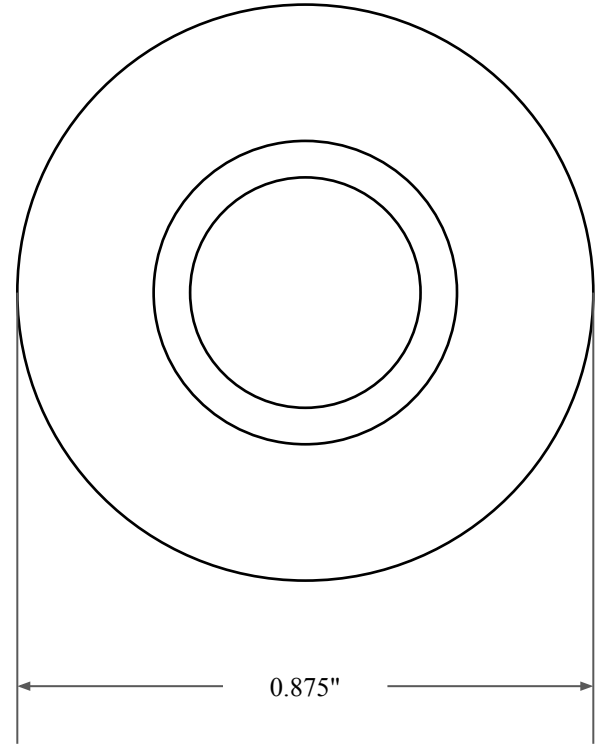

0.250"



0.375"



0.875"

 GLOBAL O-RING and SEAL ALL-AROUND BETTER	PART NUMBER OS371SB2
14450 John F. Kennedy Blvd. Houston, TX 77032	www.globaloring.com
Information in this drawing is provided for reference only	

Inch Oil Seal - Nitrile Style SB2
SGL LIP W/ SPR, MTL OD