

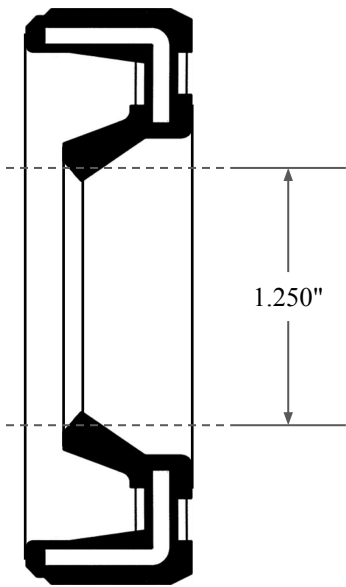

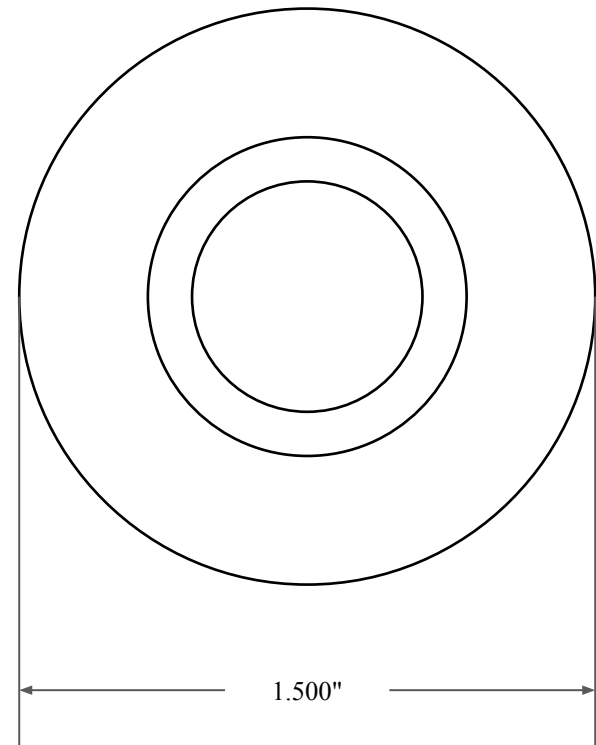

0.156"



1.250"



1.500"

 <b>GLOBAL O-RING</b> and SEAL ALL-AROUND BETTER	PART NUMBER <b>OS3984VC</b>
14450 John F. Kennedy Blvd. Houston, TX 77032	www.globaloring.com
Information in this drawing is provided for reference only	
Inch Oil Seal - Nitrile Style VC SGL LIP NO SPR, RBR OD	