

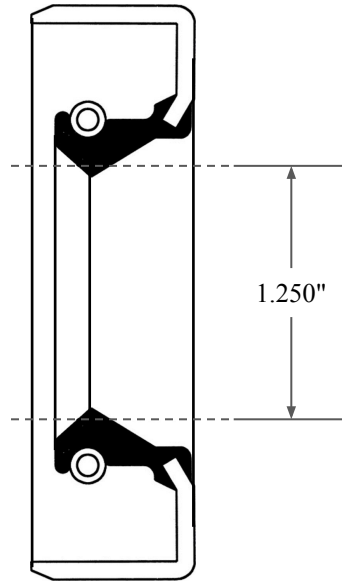

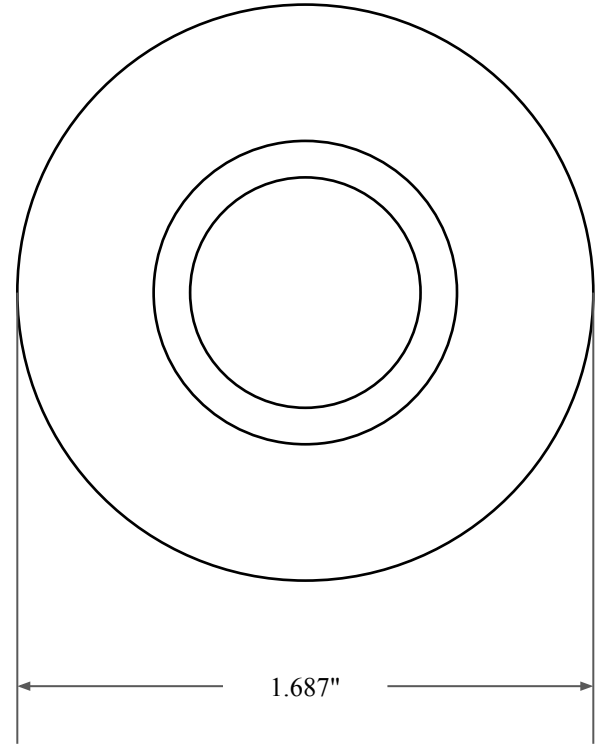

0.250"



1.250"



1.687"

 GLOBAL O-RING and SEAL ALL-AROUND BETTER	PART NUMBER OS4008SB2
14450 John F. Kennedy Blvd. Houston, TX 77032	www.globaloring.com
Information in this drawing is provided for reference only	

Inch Oil Seal - Nitrile Style SB2
SGL LIP W/ SPR, MTL OD