

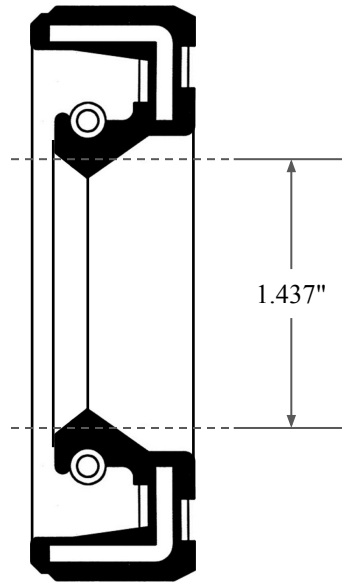

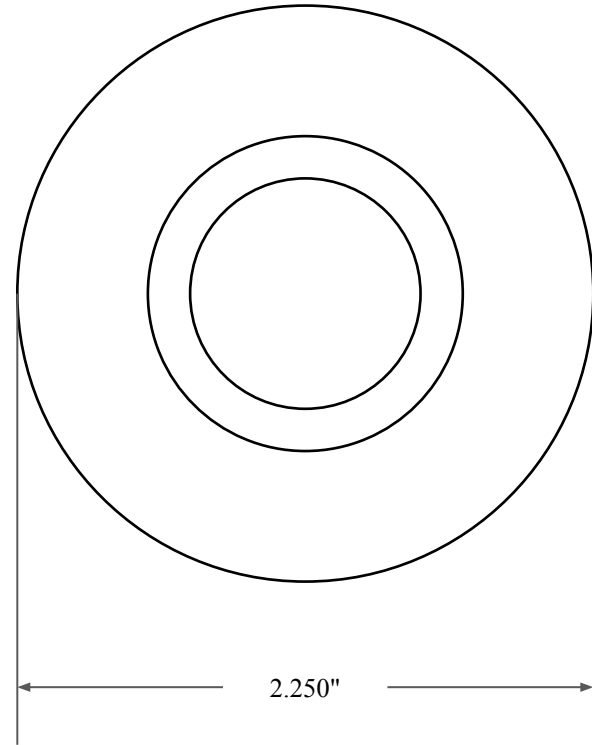

0.375"



1.437"



2.250"

 <b>GLOBAL O-RING</b> and SEAL ALL-AROUND BETTER	PART NUMBER <b>OS5062SC</b>
14450 John F. Kennedy Blvd. Houston, TX 77032 <a href="http://www.globaloring.com">www.globaloring.com</a>	<b>Inch Oil Seal - Nitrile Style SC</b>
Information in this drawing is provided for reference only	

**SGL LIP W/ SPR, RBR OD**