

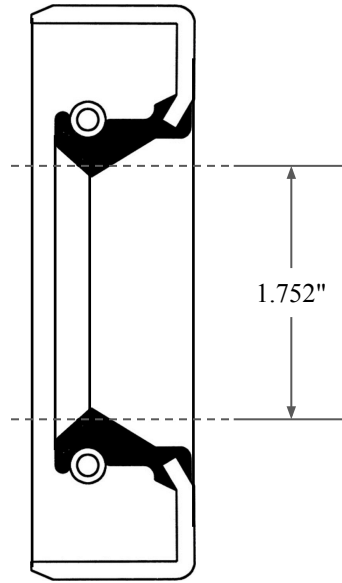

0.375"

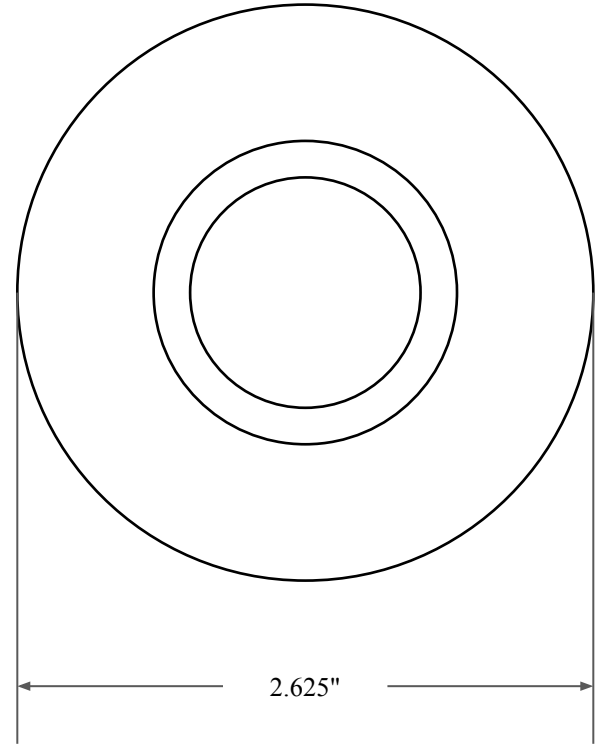

1.752"



2.625"



**GLOBAL O-RING**  
and SEAL  
ALL-AROUND BETTER

14450 John F. Kennedy Blvd.  
Houston, TX 77032

[www.globaloring.com](http://www.globaloring.com)

Information in this drawing is provided for reference only

PART  
NUMBER

**OS6617SB2**

Inch Oil Seal - Nitrile Style SB2  
SGL LIP W/ SPR, MTL OD