

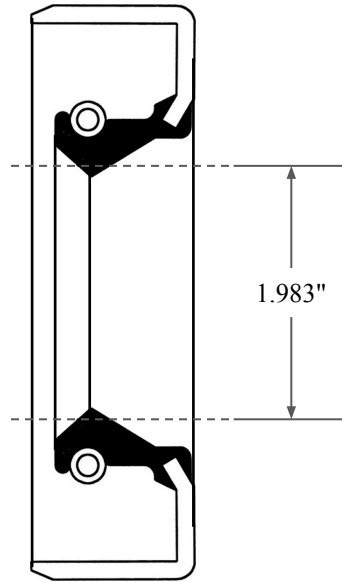

0.312"

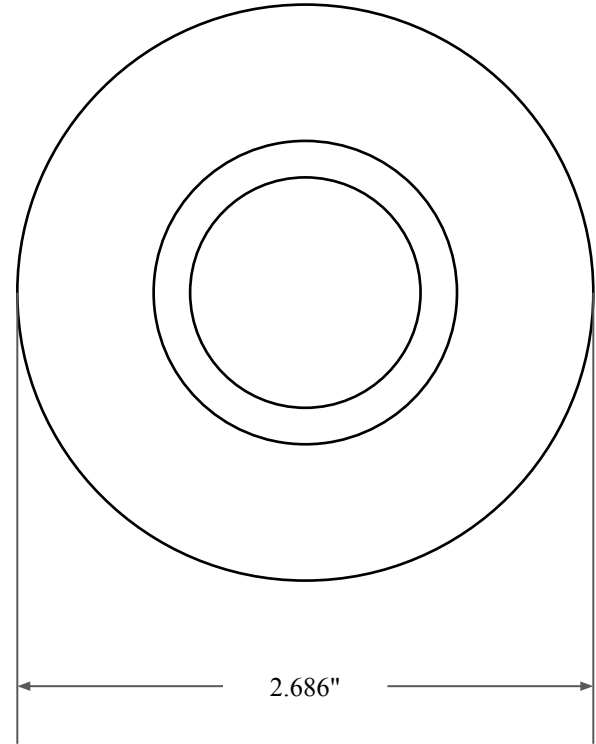

1.983"



2.686"



14450 John F. Kennedy Blvd.
Houston, TX 77032

www.globaloring.com

Information in this drawing is provided for reference only

PART
NUMBER

OS7530SB2

Inch Oil Seal - Nitrile Style SB2
SGL LIP W/ SPR, MTL OD