

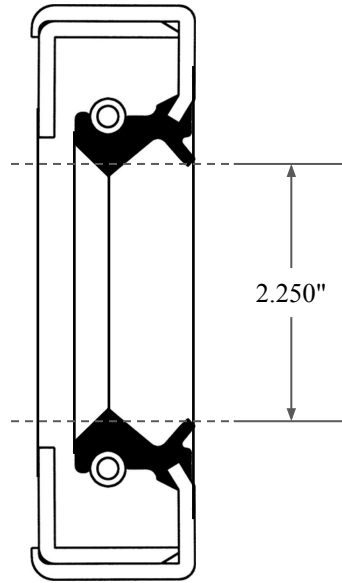

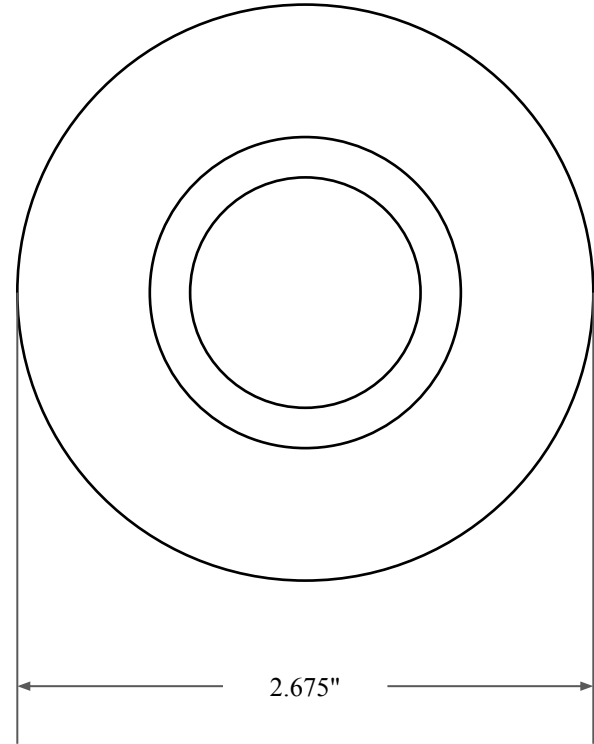

0.539"



2.250"



2.675"

|  |   |
|--|---|
|  <p><b>GLOBAL O-RING</b><br/>and SEAL<br/>ALL-AROUND BETTER</p> | PART NUMBER <b>OS8334TA2</b>  |
| 14450 John F. Kennedy Blvd.<br>Houston, TX 77032   | Inch Oil Seal - Nitrile Style 1A2<br>DUAL LIP W/ SPR, MTL OD W/ RFG |
| Information in this drawing is provided for reference only   |   |

PLATE