

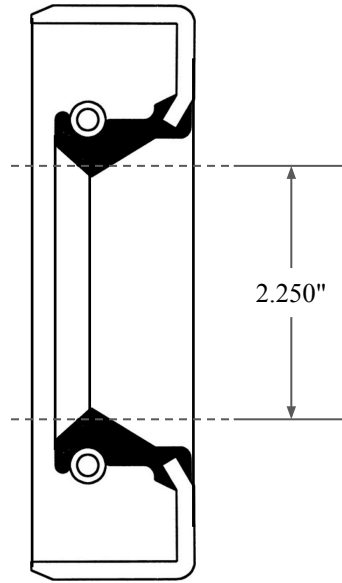

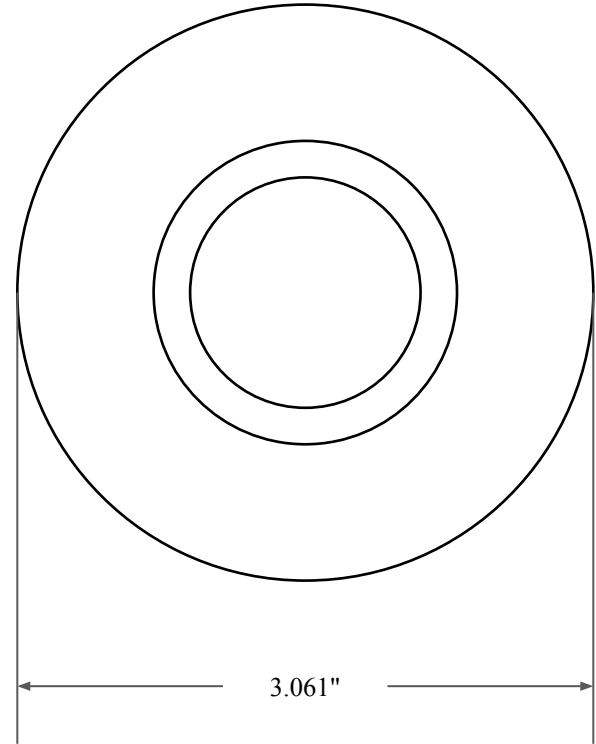

0.375"



2.250"



3.061"

 GLOBAL O-RING and SEAL ALL-AROUND BETTER	PART NUMBER OS8360SB2
14450 John F. Kennedy Blvd. Houston, TX 77032 www.globaloring.com	Inch Oil Seal - Nitrile Style SB2 SGL LIP W/ SPR, MTL OD
Information in this drawing is provided for reference only	