

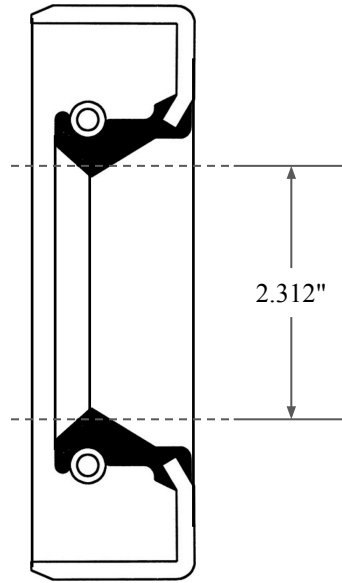

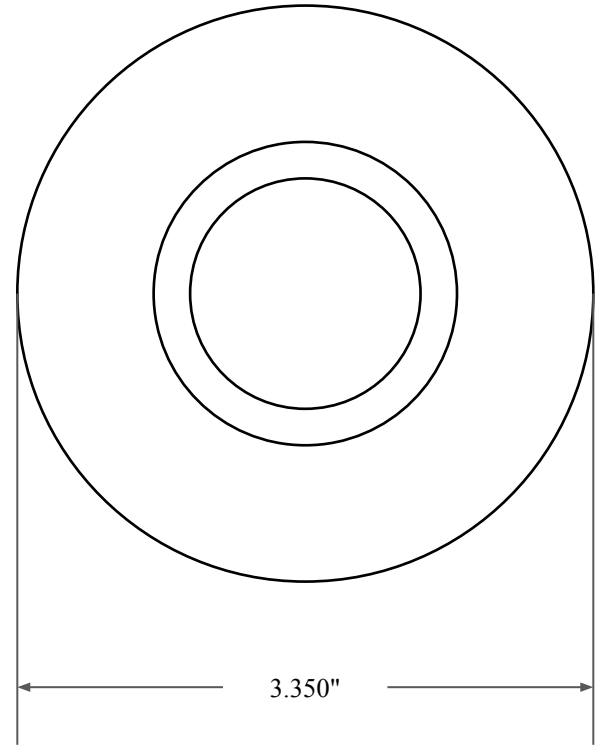

0.312"



2.312"



3.350"

 <b>GLOBAL O-RING</b> and SEAL ALL-AROUND BETTER	PART NUMBER <b>OS8546SB2</b>
14450 John F. Kennedy Blvd. Houston, TX 77032	www.globaloring.com
Information in this drawing is provided for reference only	

Inch Oil Seal - Nitrile Style SB2  
SGL LIP W/ SPR, MTL OD