

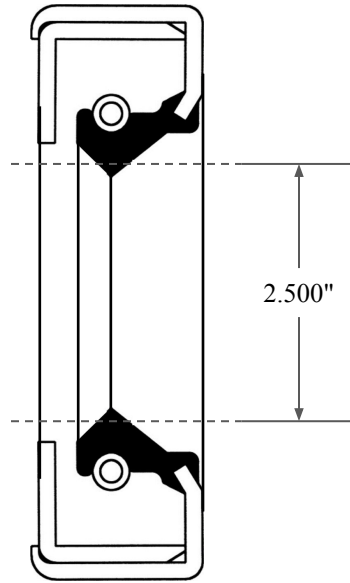

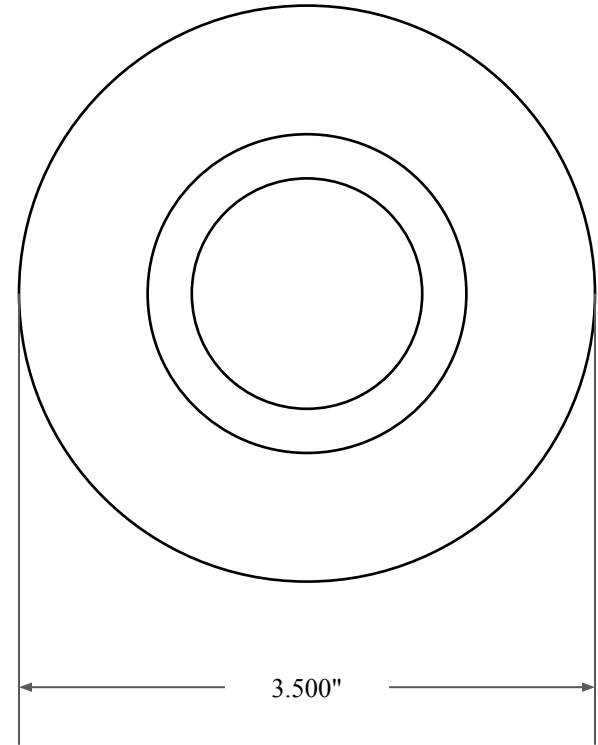

0.438"



2.500"



3.500"

|   |   |
|---|---|
|  <b>GLOBAL O-RING</b><br>and SEAL<br>ALL-AROUND BETTER | PART<br>NUMBER<br><b>OS9042SA2</b>  |
| 14450 John F. Kennedy Blvd.<br>Houston, TX 77032<br><a href="http://www.globaloring.com">www.globaloring.com</a>                            | Inch Oil Seal - Nitrile Style SA2<br>SGL LIP W/ SPR, MTL OD W/ RFG<br>PLATE |
| Information in this drawing is provided for reference only  |   |