

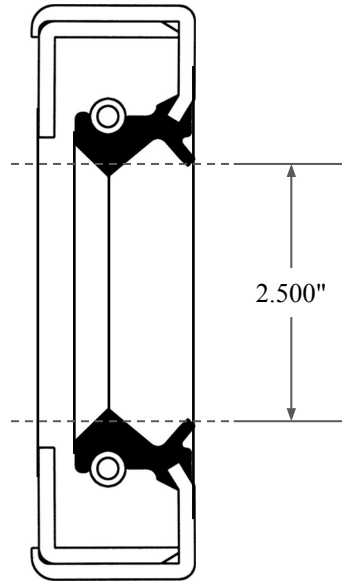

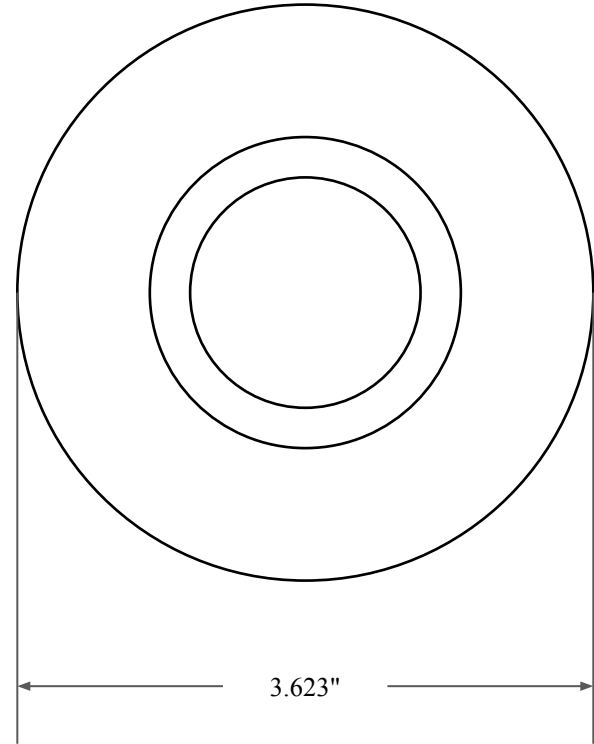

0.375"



2.500"



3.623"

 <b>GLOBAL O-RING</b> and SEAL ALL-AROUND BETTER	PART NUMBER <b>OS9067TA2</b>
14450 John F. Kennedy Blvd. Houston, TX 77032 <a href="http://www.globaloring.com">www.globaloring.com</a>	Inch Oil Seal - Nitrile Style 1A2 DUAL LIP W/ SPR, MTL OD W/ RFG PLATE
Information in this drawing is provided for reference only	