

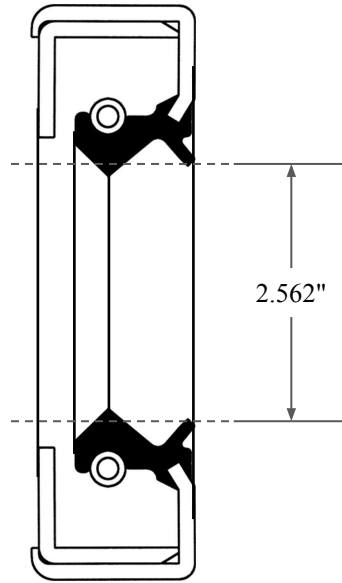

0.375"

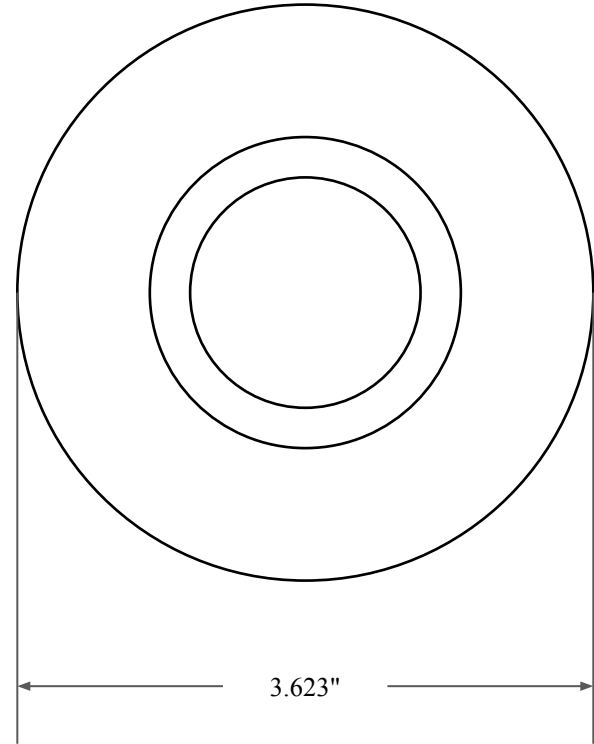

2.562"



3.623"



14450 John F. Kennedy Blvd.  
Houston, TX 77032

[www.globaloring.com](http://www.globaloring.com)

Information in this drawing is provided for reference only

PART  
NUMBER

**OS9236TA2**

Inch Oil Seal - Nitrile Style 1A2  
DUAL LIP W/ SPR, MTL OD W/ RFG  
PLATE