

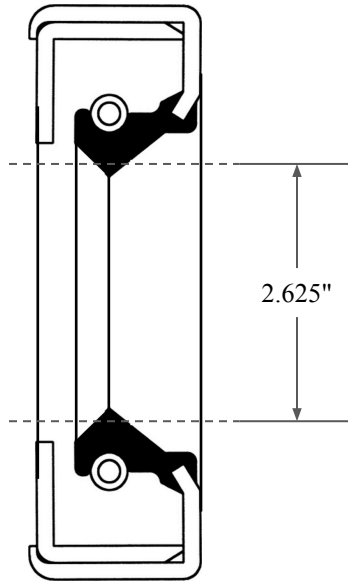

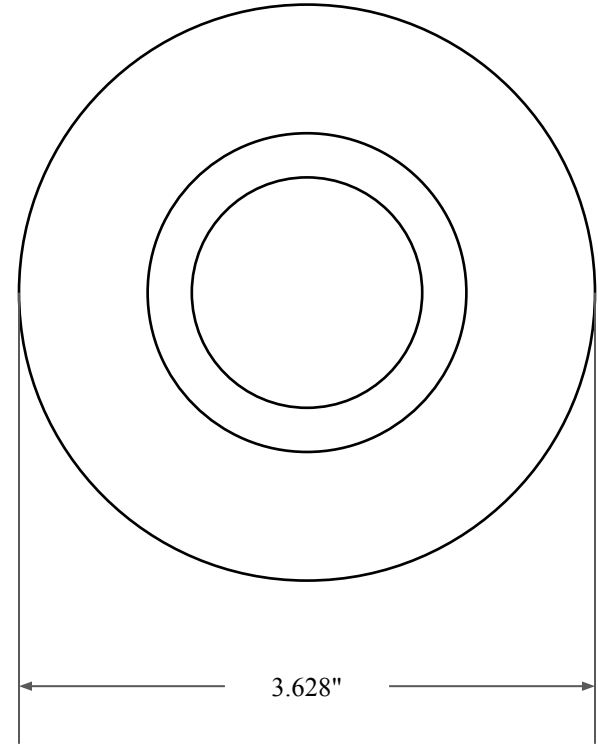

0.468"



2.625"



3.628"

 GLOBAL O-RING and SEAL ALL-AROUND BETTER	PART NUMBER OS9341SA2
14450 John F. Kennedy Blvd. Houston, TX 77032 www.globaloring.com	Inch Oil Seal - Nitrile Style SA2 SGL LIP W/ SPR, MTL OD W/ RFG PLATE
Information in this drawing is provided for reference only	