

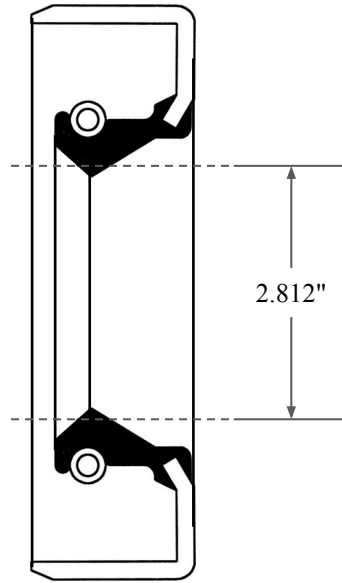

0.438"

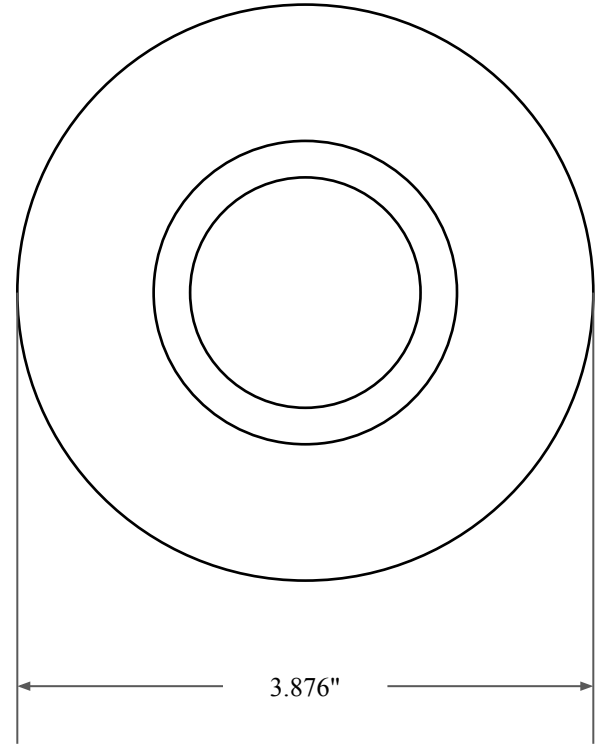

2.812"



3.876"



14450 John F. Kennedy Blvd.      www.globaloring.com  
Houston, TX 77032

Information in this drawing is provided for reference only

PART  
NUMBER

**OS9672SB2**

Inch Oil Seal - Nitrile Style SB2  
SGL LIP W/ SPR, MTL OD