

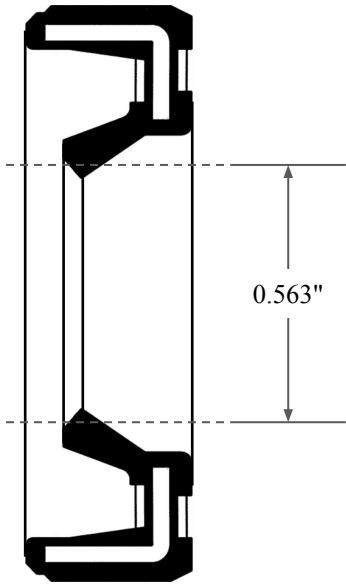

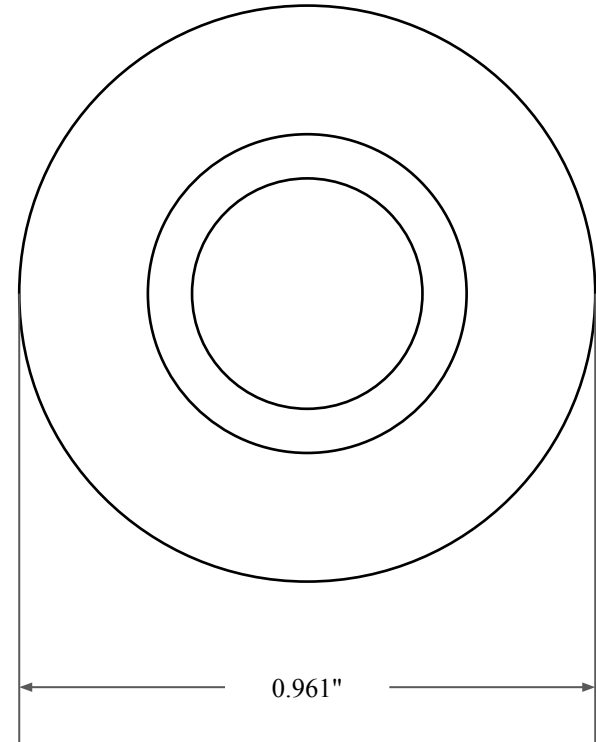

0.196"



0.563"



0.961"

 ALL-AROUND BETTER	PART NUMBER <b>OS971VC</b>
14450 John F. Kennedy Blvd. Houston, TX 77032	www.globaloring.com
Information in this drawing is provided for reference only	

Inch Oil Seal - Nitrile Style VC  
SGL LIP NO SPR, RBR OD